



FROMMM | AIRPAD
SYSTEMS

AP100

Compact airpad system

- Suitable for every work station
- Heavy duty design for continuous operation
- Modular setup for enhanced productivity



AIRPAD AP100

FROMM's compact airpad device for all protective packaging needs

Suitable for every work station

- Small footprint for easy integration
- Stand-alone or multiple operator configurations
- Ideal for decentralized packaging stations

Designed for optimum ergonomics

- Fast learning and user-friendly operation
- Simple control panel
- Silent hopper operation
- Quick and easy film loading
- Rotating display for easy panel reading

Modular setup for enhanced productivity

- Overhead hoppers and on-floor storage bins
- Automatic replenishment
- Foot switch operation
- Manual pad holder for easy dispensing
- Front and side embedded photocells for automatic use



FROMM technology

- Heavy duty design for continuous operation
- Efficient technical support
- End-of-the-line expertise



AP100 Technical specifications

- Power supply: 90-240V-50/60Hz
- Weight: 11,4 kg (without options)
- Speed: 10-16 m/mn
- Film quality: PE
- Film width: 200 mm, 400 mm

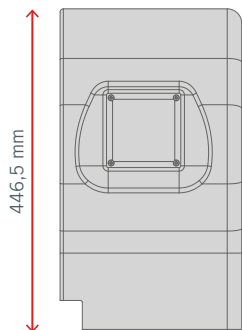
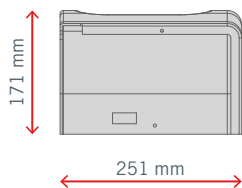

AirPad AP100
code 50.2103

Options

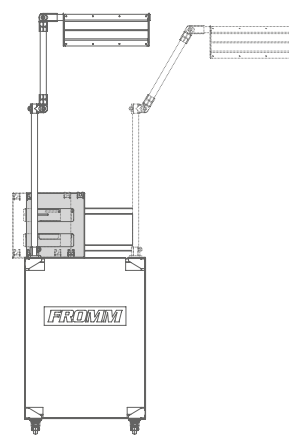
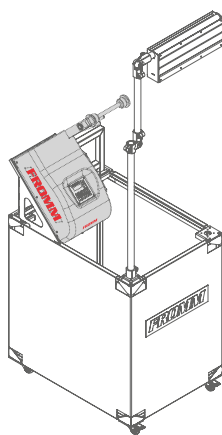

Compact mobile bin with articulated arm and pad holder
code 50.2119

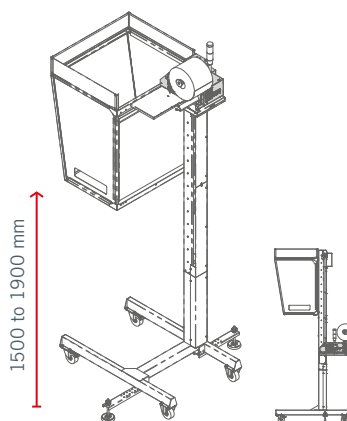



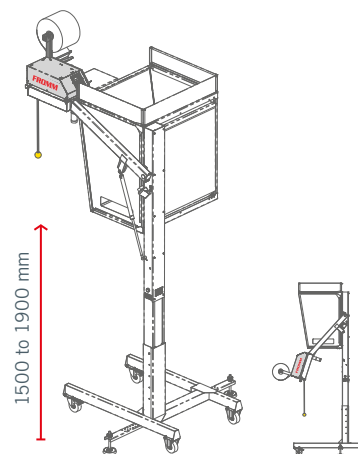











Electric overhead dispensing system
code 50.2118



Manual overhead dispensing system
code 50.2117

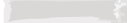

The right film and the right pad

		 Standard	 Strong	 Extra Strong	 Barrier	 Anti-Static	 Recycled	 Bio-based
200x80mm 			900 m 4.0-5.0 m ³ /roll					
200x120mm 				650 m 3.5-4.0 m ³ /roll	<i>In development</i>			
200x135mm 		1100 m 6.0-6.5 m ³ /roll	900 m 5.0-5.5 m ³ /roll			<i>In development</i>	<i>In development</i>	<i>In development</i>
200x200mm 		1100 m 8.5-10.0 m ³ /roll	900 m 7.0-8.0 m ³ /roll					
300x135mm 			600 m 5.0-6.0 m ³ /roll	450 m 3.5-4.0 m ³ /roll				
400x135mm* 			450 m 4.5-5.0 m ³ /roll					
400x150mm* 2 Pads 		500 m 8.5-9.0 m ³ /roll			<i>In development</i>			
400x150mm* 8 Pads 		500 m 200 m ² /roll		350 m 140 m ² /roll	<i>In development</i>			

FROMM stands for development, production, consultancy, sales, service – worldwide and from a single supplier!
Benefit from our expertise!

FROMM | AIRPAD SYSTEMS

FROMM HOLDING AG
Hinterbergstrasse 26
CH-6330 Cham
Switzerland
Tel. +41 56 419 10 20
Fax +41 56 419 10 30
www.fromm-pack.com